

# KSC13003A

**SemiHow**  
Know-How for Semiconductor

# KSC13003A

## Switch Mode series NPN silicon Power Transistor

- High voltage, high speed power switching
- Suitable for switching regulator, inverters motor controls

### Absolute Maximum Ratings TC=25°C unless otherwise noted

1.5 Amperes  
NPN Silicon Power Transistor  
20 Watts

CHARACTERISTICS	SYMBOL	RATING	UNIT
Collector-Base Voltage	$V_{CBO}$	700	V
Collector-Emitter Voltage	$V_{CEO}$	400	V
Emitter-Base Voltage	$V_{EBO}$	9	V
Collector Current(DC)	$I_C$	1.5	A
Collector Current(Pulse)	$I_{CP}$	3	A
Base Current	$I_B$	0.75	A
Collector Dissipation(Tc=25°C)	$P_C$	20	W
Junction Temperature	$T_J$	150	°C
Storage Temperature	$T_{STG}$	-65~150	°C

TO-18  
1. Base  
2. Collector  
3. Emitter



### Electrical Characteristics TC=25°C unless otherwise noted

CHARACTERISTICS	SYMBOL	Test Condition	Min	Typ.	Max	Unit
Collector-Emitter Breakdown Voltage	$V_{CEO}$	$I_C=5mA, I_B=0$	400			V
Emitter Cut-off Current	$I_{EBO}$	$V_{EB}=9V, I_C=0$			10	μA
*DC Current Gain	$h_{FE1}$ $h_{FE2}$	$V_{CE}=2V, I_C=0.5A$ $V_{CE}=2V, I_C=1A$	9 5		40	
*Collector-Emitter Saturation Voltage	$V_{CE(sat)}$	$I_C=0.5A, I_B=0.1A$ $I_C=1A, I_B=0.25A$ $I_C=1.5A, I_B=0.5A$			0.5 1 3	V V V
*Base-Emitter Saturation Voltage	$V_{BE(sat)}$	$I_C=0.5A, I_B=0.1A$ $I_C=1A, I_B=0.25A$			1 1.2	V V
Output Capacitance	$C_{ob}$	$V_{CB}=10V, f=0.1MHz$		21		pF
Current Gain Bandwidth Product	$f_T$	$V_{CE}=10V, I_C=0.1A$	4			MHz
Turn on Time	$t_{on}$	$V_{CC}=125V, I_C=2A$ $I_{B1}=0.2A, I_{B2}=-0.2A$ $R_L=125\Omega$			1.1	μs
Storage Time	$t_{stg}$				4.0	μs
Fall Time	$t_F$				0.7	μs

\* Pulse Test: Pulse Width≤300μs, Duty Cycles≤2%

Note.

Package Mark information.

<b>hFE1 Classification</b>	R	9 ~ 16	<b>S YWW Z KSC13003A</b>	S	SemiHow symbol
	O	14 ~ 21		YWW	Y; year code, WW; week code
	Y	19 ~ 26		Z	hFE1 Classification

## Typical Characteristics

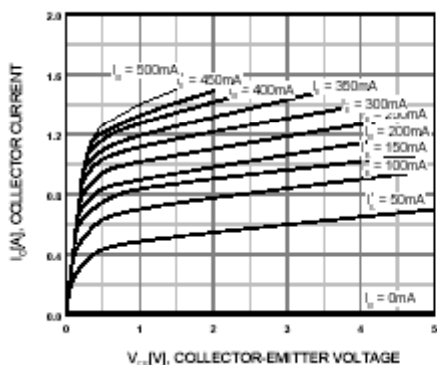

Figure 1. Static Characteristic

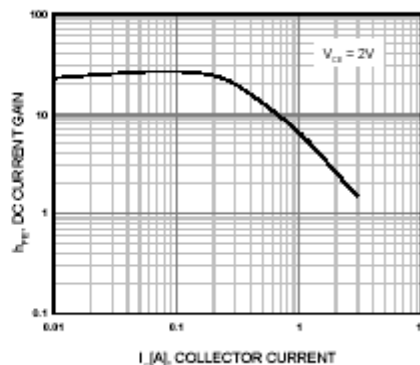

Figure 2. DC current Gain

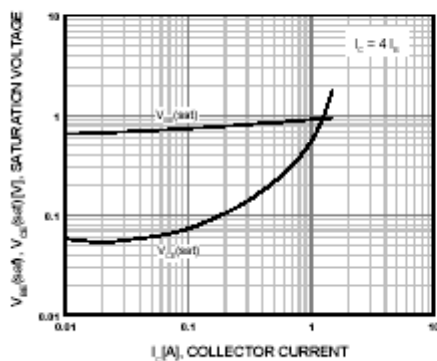

Figure 3. Base-Emitter Saturation Voltage  
Collector-Emitter Saturation Voltage



Figure 4. Switching Time

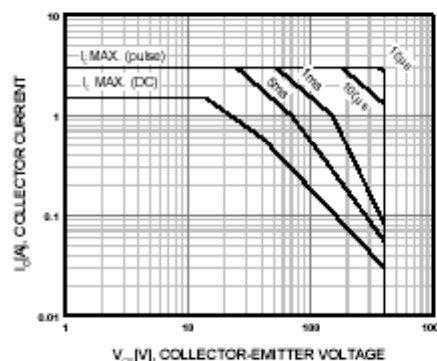

Figure 5. Safe Operating Area

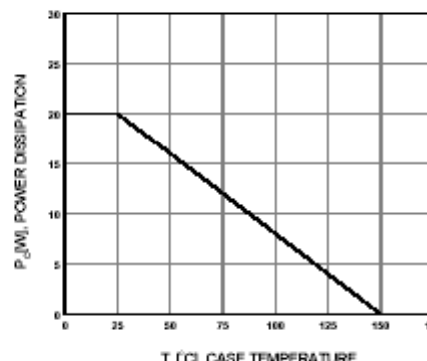
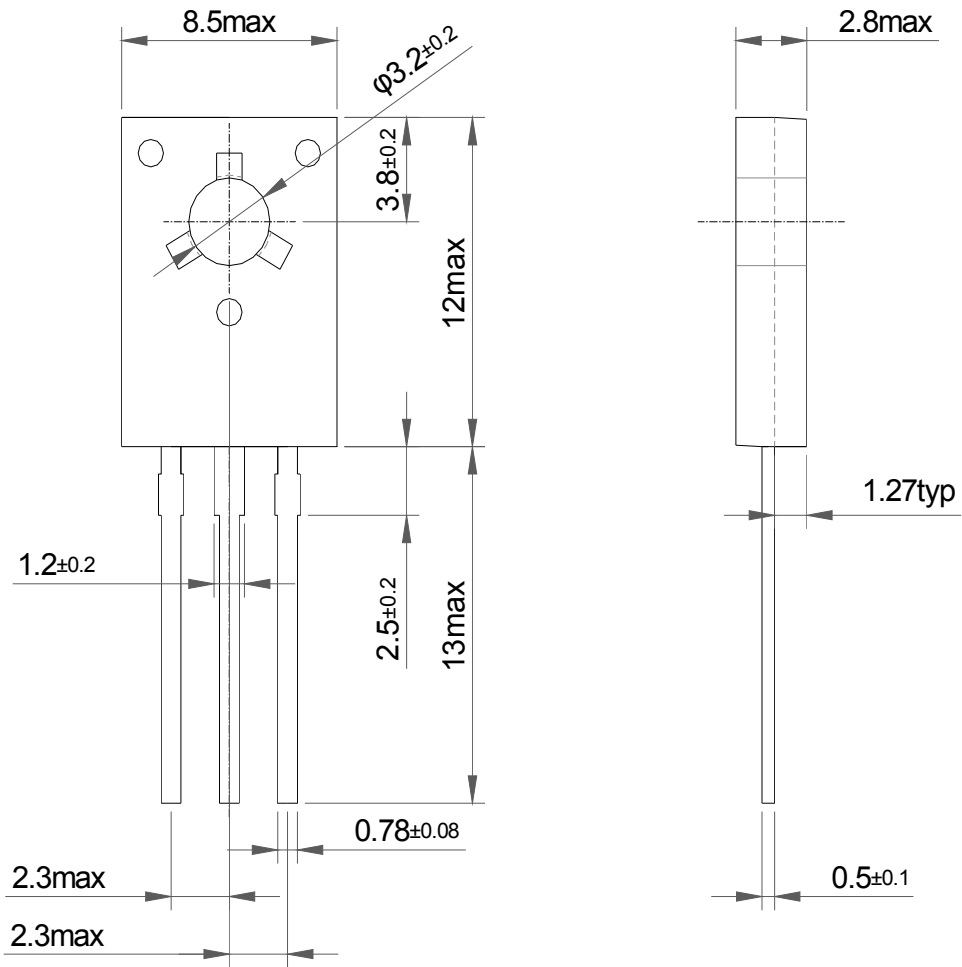

Figure 6. Power Derating

Package Dimension

TO-126

KSC13003A



Dimensions in Millimeters